

## DATENBLATT / FACT SHEET



ART.-NR:	FARBTEMPERATUR:
009-979	2700 K
004-155	3000 K
009-980	4000 K

**MODUL Q 36**

DECKENLEUCHE / CEILING-MOUNTED LUMINAIRE

Extrem flache, nur 10 mm hohe LED.next Deckenleuchte für Direktmontage, Lichtaustritt vorwiegend (ca. 95 %) direktstrahlend, breit abstrahlend, zusätzliche Deckenaufhellung sowie sehr gleichmäßige, nahezu raumhohe Wandaufhellung durch Sekundärlicht, der Konverter kann in die abgehängte Decke bzw. in die Deckenverbindungsdose integriert werden, die Leuchte kann direkt an dieser Decken-Verbindungsdose befestigt werden.

8 W LED.next ≈ 50 W Halogen

Ultra-flat LED.next ceiling-mounted luminaire (10 mm material thickness only) for direct mounting, beam mainly direct (approx. 95 %), wide beam, additional ceiling lighting and also a very even, almost floor-to-ceiling illumination of walls by secondary light, the converter can be integrated in a suspended ceiling or an in-ceiling junction box, the luminaire can be directly fastened to this in-ceiling junction box.

8 W LED.next ≈ 50 W halogen

## TECHNISCHE DATEN / TECHNICAL FACTS

### Artikel:

MODUL Q 36

### Art.-Nr.: Farbtemperatur:

009-979 2700 K

004-155 3000 K

009-980 4000 K

### Beschreibung/Ausführung:

Deckenleuchte für Direktmontage

### Hersteller:

Nimbus Group GmbH  
Siegelerstr. 41, D-70469 Stuttgart  
Tel.: +49(0)711 / 63 30 14 - 0  
Fax: +49(0)711 / 63 30 14 - 14  
info@nimbus-group.com  
www.nimbus-group.com

### Abmessungen:

122 x 122 x 10 mm

### Material:

Diffusorfläche: Acrylglas

Aufhängung: Stahl

### Gewicht:

ca. 267 g

### Lichttechnik:

**LED.next** -Technologie integriert

### Anschluss-Leistung:

8 W / 24 Volt DC / Energieeffizienzklasse A+

### Anzahl LEDs:

36 Stück

### Schutzart:

IP 20

### Lichtstrom:

546 lm

### Abstrahlcharakteristik:

breit abstrahlend

### Lichtverteilung:

95 % direktstrahlend

### RA:

80

### Prüfzeichen:



### Reinigungs- und Pflegehinweise:

Leuchte beim Reinigen vom Netz trennen. Keine ätzenden oder abrasiven Reinigungsmittel verwenden. Wir empfehlen, die Leuchte nur mit einem Microfasertuch o. ä. trocken zu reinigen.

Alle Angaben erfolgen ohne Gewähr für Irrtümer und Übertragungsfehler. Wir bitten um Verständnis, dass wir uns Änderungen in der Gestalt und Technik vorbehalten.

### product:

MODUL Q 36

### product no. colour temperature:

009-979 2700 K

004-155 3000 K

009-980 4000 K

### description/design:

ceiling luminaire for direct mounting

### manufacturer:

Nimbus Group GmbH  
Siegelerstr. 41, D-70469 Stuttgart  
Tel.: +49(0)711 / 63 30 14 - 0  
Fax: +49(0)711 / 63 30 14 - 14  
info@nimbus-group.com  
www.nimbus-group.com

### dimensions:

122 x 122 x 10 mm

### materials:

diffuser surface: acrylic glass

mounting: steel

### weight:

approx. 267 grams

### light technology:

**LED.next** -technology integrated

### required power supply:

8 W / 24 volts DC / energy efficiency class A+

### number of LEDs:

36 pcs

### degree of protection:

IP 20

### luminous flux:

546 lm

### directional characteristics:

wide beam

### light distribution:

95 % direct beam

### CRI:

80

### certificates:



### cleaning and care:

Switch off luminaire while cleaning. Do not use any corrosive or abrasive cleanser. We recommend to clean the luminaire with a dry microfibre towel only.

The information may be subject to errors in content or transmission errors; we do not accept responsibility for any such errors. We reserve the right to make changes to design and technology and apologise for any inconvenience this may cause.

## LICHTVERTEILUNGSKURVE UND ABSTRAHLCHARAKTERISTIK LIGHT DISTRIBUTION CURVE AND DIRECTIONAL CHARACTERISTICS

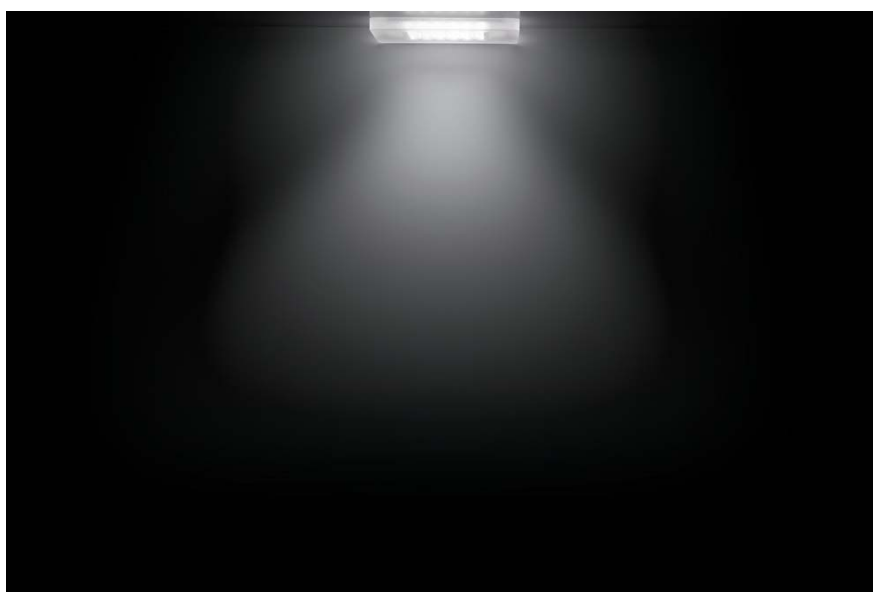
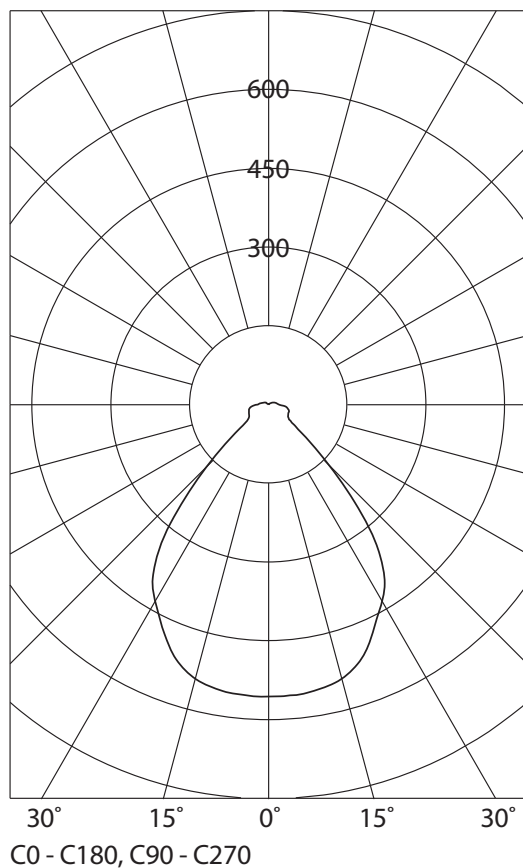

Lichtberechnungsdaten (EULUMDAT) unter [www.nimbus-group.com](http://www.nimbus-group.com)

## ISOMETRIE UND MASSE / SIZES

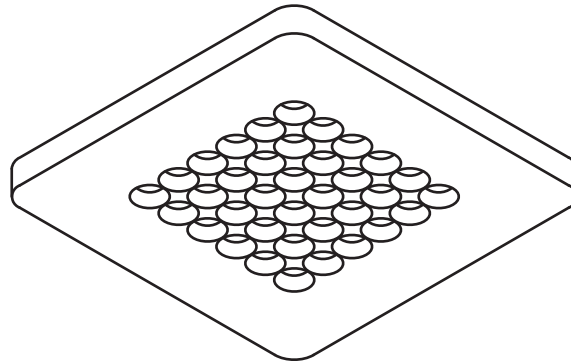

122 mm

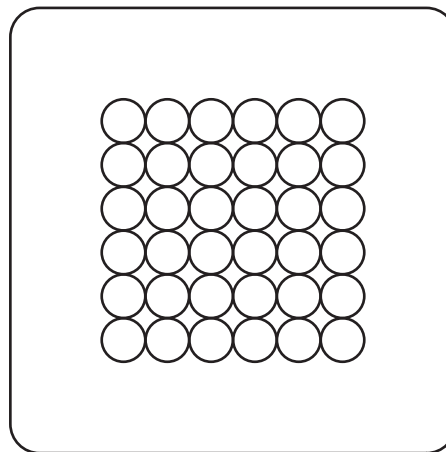

122 mm

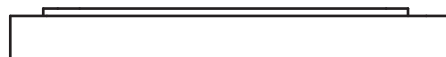

10 mm



# MODUL Q 36 LED.next

DECKENLEUCHTE / CEILING-MOUNTED LUMINAIRE

009-979 . 004-155 . 009-980 - MONTAGE / MOUNTING

FÜR HOHLRAUMEINBAU / DIREKTMONTAGE (ABGEHÄNGTE DECKE)  
 FOR PLASTERBOARD / DIRECT MOUNTING (SUSPENDED CEILING)

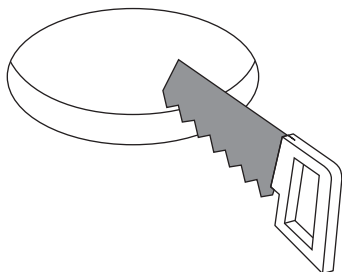

1

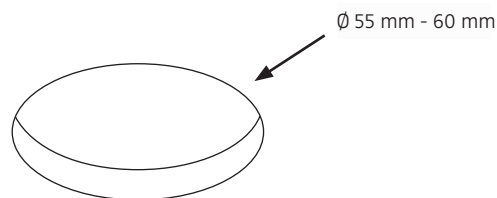
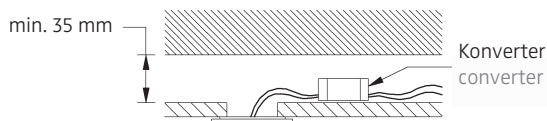

2

Anschluss mit 230 V ~  
 connection to 230 V AC

Anschluss mit 24 V DC  
 connection to 24 V DC

Anschluss mit 230 V ~  
 connection to 230 V AC

Anschluss mit 24 V DC  
 connection to 24 V DC

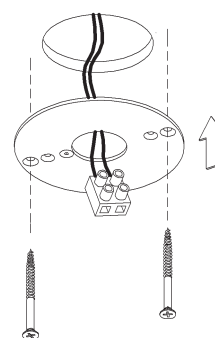
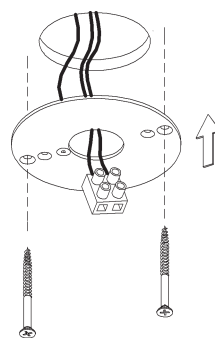
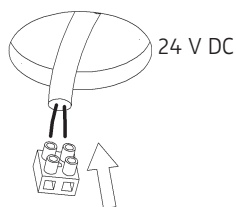
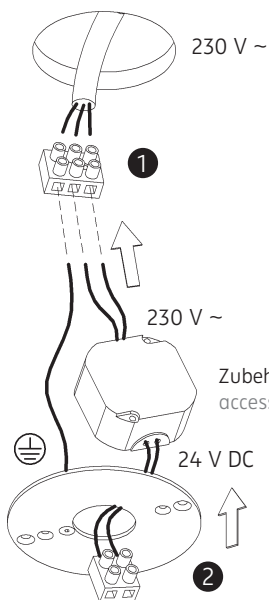

Der elektrische Anschluß darf nur vom Fachmann ausgeführt werden!  
 Must be installed by a qualified electrician only!

3

4

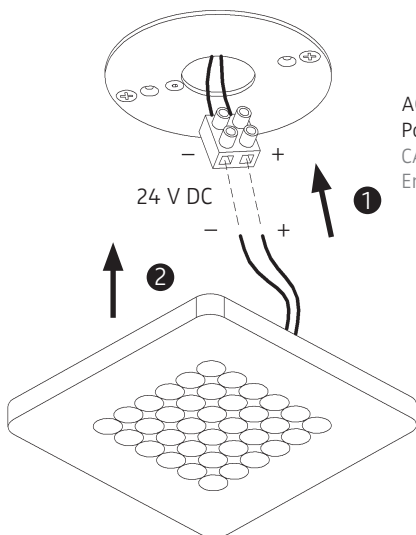

ACHTUNG:  
 Polarität beachten!  
 CAUTION:  
 Ensure correct polarity!

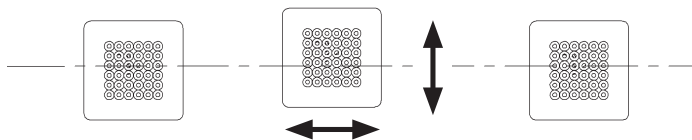
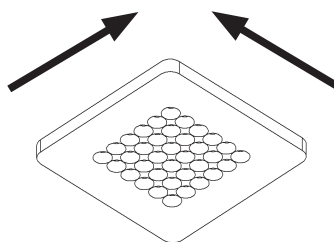

5

6

FÜR HOHLRAUMEINBAU IN PORÖSE MATERIALIEN  
FOR INSTALLATION IN POROUS MATERIALS

mit geeigneter Hohlraumdose  
with suitable ceiling junction box

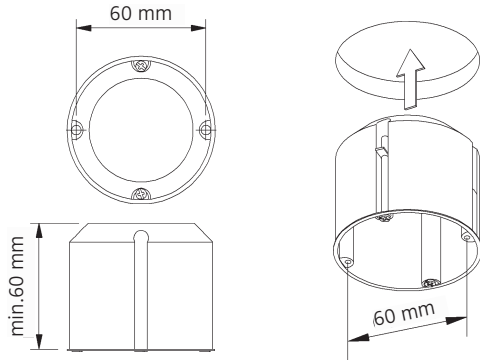
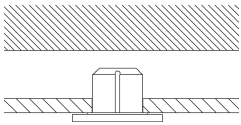

1

FÜR UNTERPUTZ / MAUERWERK  
FOR BRICK / HOLLOW BLOCKS

mit geeigneter Decken-Verbindungsdose  
with suitable ceiling junction box

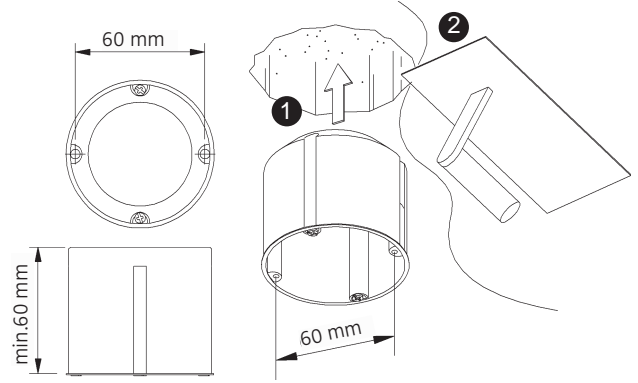
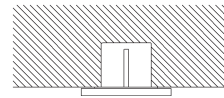

1

Anschluss mit 230 V ~  
connection to 230 V AC

Anschluss mit 24 V DC  
connection to 24 V DC

**ACHTUNG:** Beim Einbau von Konvertern in Deckendosen die Planungshinweise auf unserer Homepage beachten!  
**CAUTION:** Keep in mind the planning advice on our homepage when you insert converters into ceiling boxes!

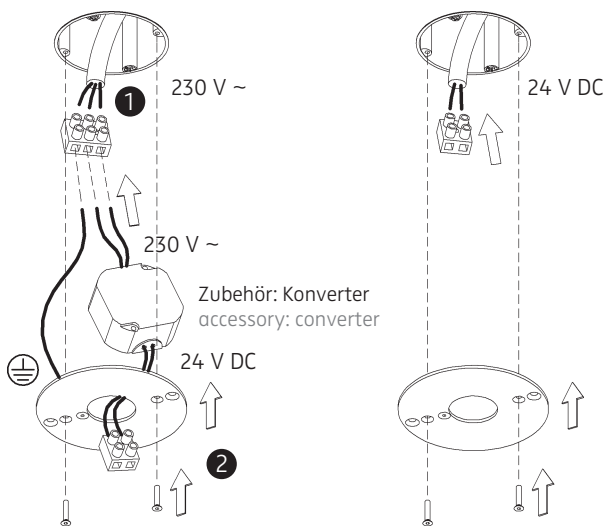

Der elektrische Anschluß darf nur vom Fachmann ausgeführt werden!

Must be installed by a qualified electrician only!

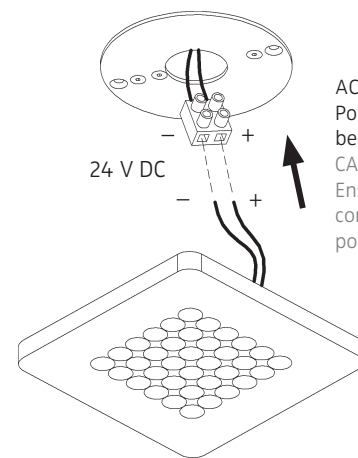

**ACHTUNG:** Polarität beachten!  
**CAUTION:** Ensure correct polarity!

2

3

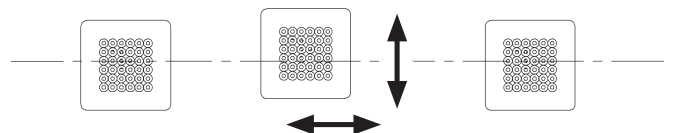
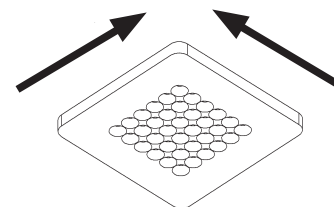
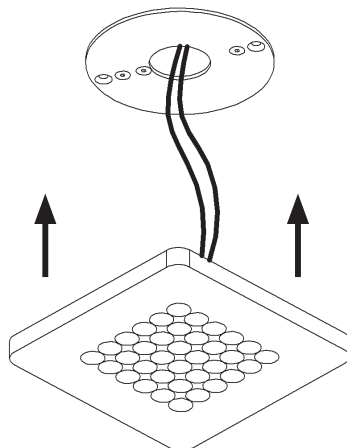

4

5

**MONTAGE IN DECKEN-VERBINDUNGSDOSE FÜR BETON**  
**INSTALLATION IN CEILING JUNCTION BOX FOR CONCRETE**  
 mit geeigneter Decken-Verbindungsdose, z.B. Spelsberg U71  
 with suitable ceiling junction box, e.g. Spelsberg U71

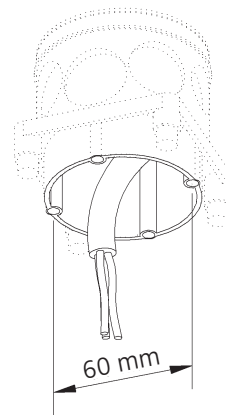
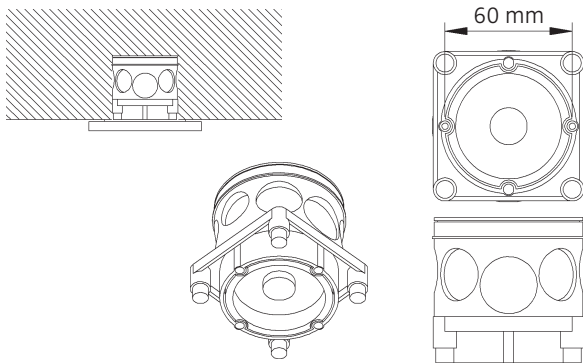

1

Anschluss mit 230 V ~  
 connection to 230 V AC

Anschluss mit 24 V DC  
 connection to 24 V DC

**ACHTUNG:** Beim Einbau von Konvertern in Deckendosen die Planungshinweise auf unserer Homepage beachten!  
**CAUTION:** Keep in mind the planning advice on our homepage when you insert converters into ceiling boxes!

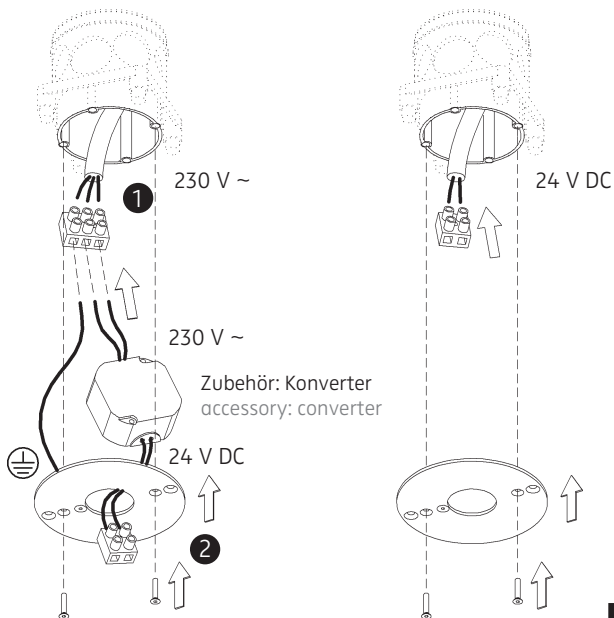

Der elektrische Anschluß darf nur vom Fachmann ausgeführt werden!

Must be installed by a qualified electrician only!

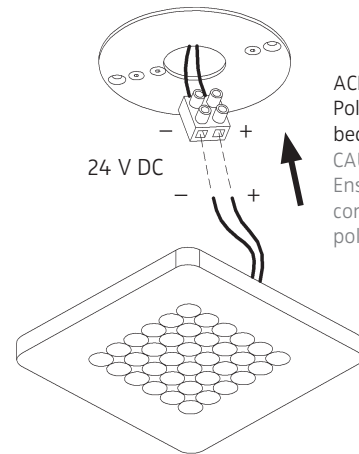

**ACHTUNG:** Polarität beachten!  
**CAUTION:** Ensure correct polarity!

2

3

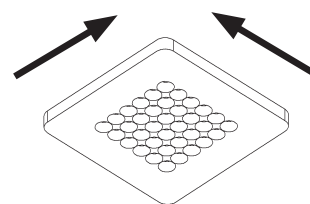
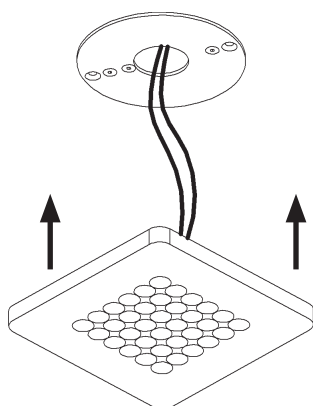

4

5

009-979 . 004-155 . 009-980

24 V DC / Bestückung LED.next 8 W  
 24 V DC / lamp type LED.next 8 W

Schutzart IP 20  
 protection degree IP 20

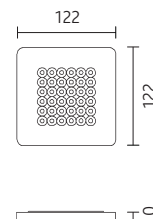

**MODUL Q 36 LED.next**

DECKENLEUCHTE / CEILING-MOUNTED LUMINAIRE

009-979 . 004-155 . 009-980

DECKENMONTAGERING MODUL Q 36, MODUL Q 49, MODUL Q 64

CEILING MOUNTING RING MODUL Q 36, MODUL Q 49, MODUL Q 64

