

63017 Qubit Q Outdoor

LED Wandleuchte

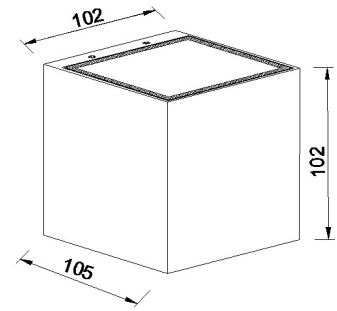

LED:	BRIDGELUX V8
Betriebsart:	230V AC
Leistung:	9.3W
CRI:	≥80
Farbtemperatur:	2700K
Lichtstrom:	893lm
Stromversorgung:	Konverter integriert
Dimmbar:	Nicht dimmbar
Erhältliche Farben:	Weiss matt, grau, dunkelgrau
Optik:	-
Abstrahlwinkel:	-
Lichtaustritt	Asymmetrisch
Frontabdeckung:	Schutzglas klar
Drehbar:	-
Schwenkbar:	-
Schutzart:	IP54
Masse:	102x102x105mm
Montage:	Montageplatte

LED Wandleuchte
Aluminium

